

K 23 PC - 8 Ohm

Art. No. 2823



2,3 cm (0,9") Kleinlautsprecher zur Montage auf Leiterplatten.

2.3 cm (0.9") miniature speaker for printed circuit board assembly.

Anwendungsmöglichkeiten / Typical applications

- Signalausgabe in Maschinen oder Geräten
- Signal output in machines or devices

K 23 PC - 8 Ohm

Art. No. 2823

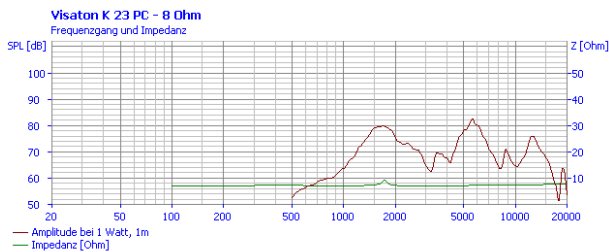
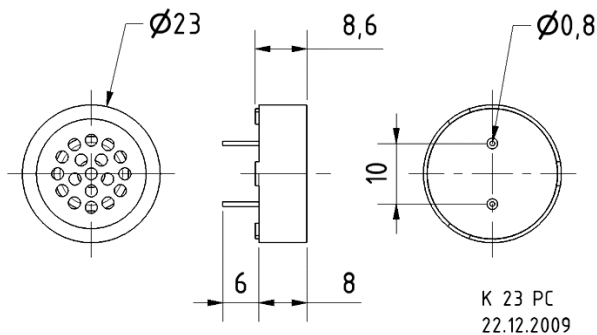
Technische Daten / Technical data

Nennbelastbarkeit Rated power	0,2 W
Musikbelastbarkeit Maximum power	0,5 W
Nennimpedanz Z Nominal impedance Z	8 Ohm
Übertragungsbereich Frequency response	900–16000 Hz
Mittlerer Schalldruckpegel Mean sound pressure level	73 dB (1 W/1 m)
Resonanzfrequenz f_s Resonance frequency f_s	1740 Hz
Schwingspuldurchmesser Voice coil diameter	8 mm
Wickelhöhe Height of winding	1,5 mm
Gewicht netto Net weight	0,003 kg
Rastermaß Wire spacing	10 mm
Anschlüsse Connections	0,8 mm
Temperaturbereich Temperature range	-25 ... 70 °C

01.10.2015